



# CorePro LED PLC 2P

## LED PLC 8.5W 840 2P G24d-3

The CorePro LED PLC 2P integrates a LED light source into a traditional fluorescent form factor. This product is the ideal solution for uplamping in general lighting applications: it meets basic lighting requirements, offers significant energy savings and is environmentally friendly.

### Product data

General Information		Warm-up time to 60% light (nom.)	
Cap base	G24D-3 [ G24d-3]		0.5 s
EU RoHS compliant	Yes	Power factor (nom.)	0.9
Nominal lifetime (nom.)	30000 h	Voltage (Nom)	220-240 V
Switching cycle	50,000X	<b>Temperature</b>	
<b>Light Technical</b>		T-ambient (max.)	35 °C
Colour Code	840 [ CCT of 4,000 K]	T-ambient (min.)	-20 °C
Technical Beam Angle (Nom)	120 °	T storage (max.)	65 °C
Lamp Luminous Flux 25°C EL (Nom)	1000 lm	T storage (min.)	-40 °C
Colour Designation	Cool White (CW)	T-Case maximum (nom.)	75 °C
Colour Temperature, horizontal (Nom)	4000 K	<b>Controls and Dimming</b>	
Lamp Luminous Efficacy EM (Nom)	117.00 lm/W	Dimmable	No
Colour consistency	<6	<b>Mechanical and Housing</b>	
Colour Rendering Index,horiz (Nom)	83	Product length	200 mm
LLMF at end of nominal lifetime (nom.)	70 %	Bulb shape	Tube, single-ended
<b>Operating and Electrical</b>		<b>Approval and Application</b>	
Input frequency	50 to 60 Hz	Energy-saving product	Yes
Power (Rated) (Nom)	8.5 W	Approval marks	TUV CE marking RoHS compliance KEMA Keur certificate
Lamp current (max.)	43 mA		
Lamp current (min.)	33 mA		
Starting time (nom.)	0.5 s		

# CorePro LED PLC 2P

Energy consumption kWh/1,000 hours	11 kWh
<b>Product Data</b>	
Full product code	871869667001900
Order product name	LED PLC 8.5W 840 2P G24d-3
EAN/UPC – product	8718696670019
Order code	929001201308

SAP numerator – quantity per pack	1
Numerator – packs per outer box	10
SAP material	929001201308
SAP net weight (piece)	0.090 kg

## Dimensional drawing

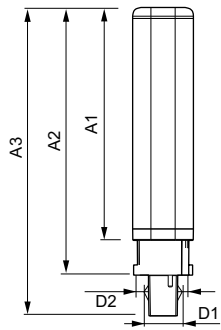

LED PLC 8.5W 840 2P G24d-3

Product	D1	D2	A1	A2	A3
LED PLC 8.5W 840 2P G24d-3	24.3 mm	28.4 mm	128.8 mm	148 mm	170.6 mm

## Photometric data

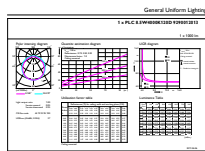

LEDtube PLC 100mm 9W G24D-3 840 1000lm

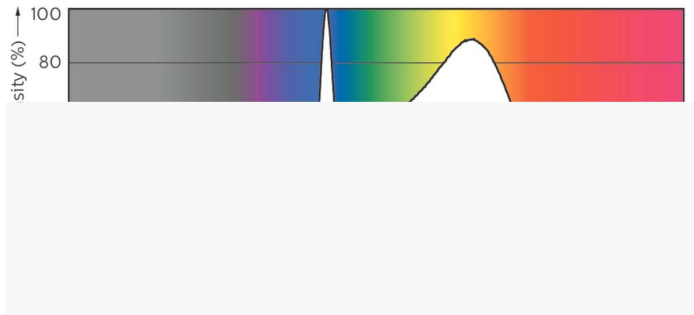

LEDtube PLC 100mm 9W G24Q-3 840 1000lm

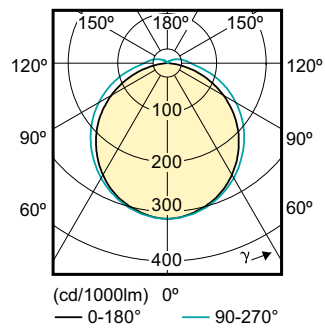

# CorePro LED PLC 2P

## Lifetime

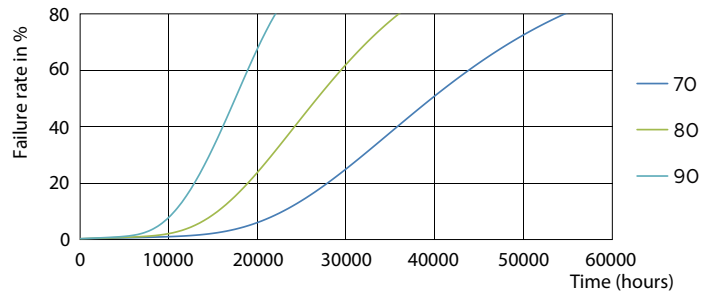
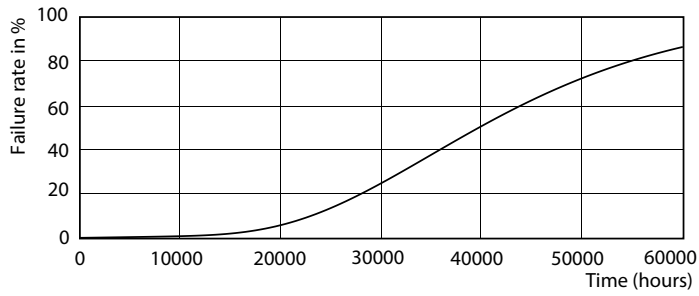

LEDtube PLC 100mm 9W G24D-3 830 950lm

LEDtube PLC 100mm 9W G24D-3 830 950lm

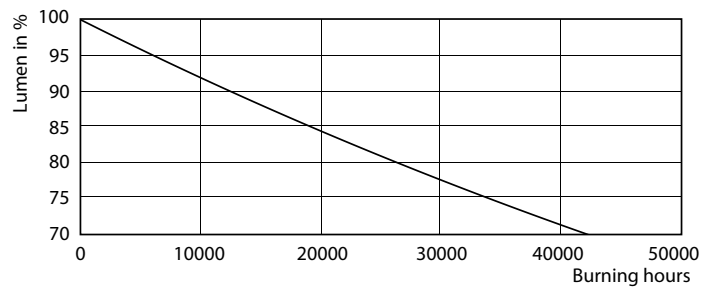
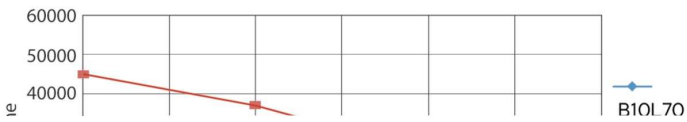

LEDtube PLC 100mm 9W G24D-3 830 950lm

LEDtube PLC 100mm 9W G24D-3 830 950lm

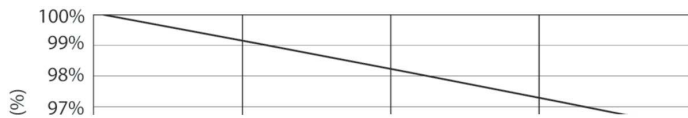

LEDtube PLC 100mm 9W G24D-3 830 950lm

## CorePro LED PLC 2P

