



Dynalite Multipurpose Controllers

Dynalite Multipurpose Controllers

Within any project, many different lighting load types may be required to achieve a desired result. Each of these load types may require a different style of control. The Philips Dynalite range of multipurpose controllers allows customization of output types via different output module units. When using DIN-rail multipurpose controllers, a specific type of control can be chosen for each circuit: relay, leading-edge dimmer, trailing-edge dimmer, ballast control, controller with out-of-the-box functionality, fan control, and blind/screen control. In any combination, multiple load types can be controlled from a single device. This simplifies installation and prevents wasted capacity of circuits that are not required.

Benefits

- Controllers support distributed intelligence, i.e. each device has a CPU with presets and can act as a stand-alone control unit
- Some devices have out-of-the-box functionality with re-configuration capability
- Simplified network messages and commissioning process

Features

- Controllers can directly drive the different lighting groups within projects
- Controllers support an industry-standard RS485 port to communicate with other devices on the DyNet network, as well as with 3rd-party devices like HVAC, network devices, user interfaces
- Available in both DIN-rail and wall-box configurations
- Devices can store over 170 presets, allowing recall of complex switching logic from simple network messages
- Preset scenarios are stored within each relay device

Application

- Depends on the lighting system in which the controls are used

Dynalite Multipurpose Controllers

Versions

DDMC802 8 x 2A Multipurpose Modular Controller



DGLM105 1 x 5 A Leading edge dimmer module



DGRM204 2 x 4 A Relay control module



DGTM402 4 x 2 A Trailing edge dimmer module

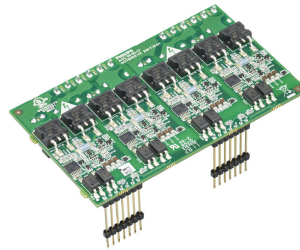

DGTM104 1 x 4 A Trailing edge dimmer module

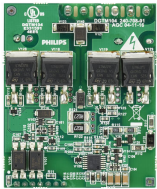

DGTM202 2 x 2 A Trailing edge dimmer module

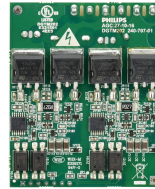

Dimensional drawing

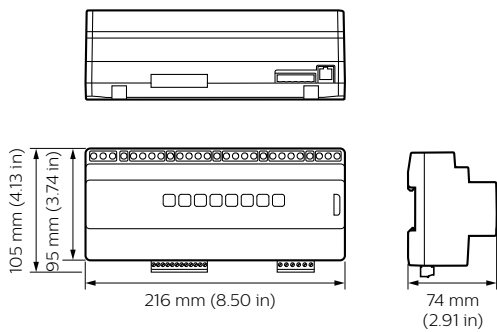

Dynalite Multipurpose Controllers

Product details

DDMC802 front detail



DGLM105 1 x 5 A Leading edge dimmer module

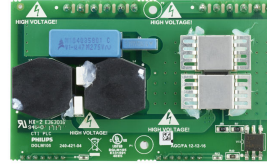

DGRM204 2 x 4 A Relay control module

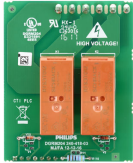

DGTM402 4 x 2 A Trailing edge dimmer module

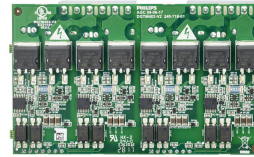

DGTM104 1 x 4 A Trailing edge dimmer module

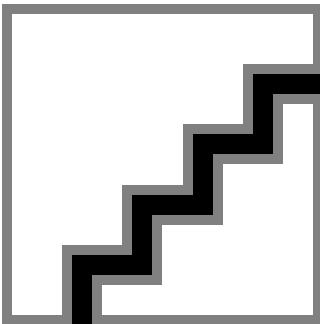

DGTM202 2 x 2 A Trailing edge dimmer module

